

PLAN

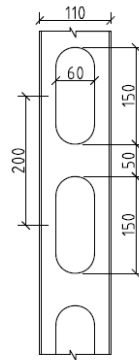

ELEVATION

### 110mm Profile Panel

The 110mm profile panel can be installed vertically to act as the main form for the wall or horizontally for beam applications.

Panels can be provided with clear or white faces.

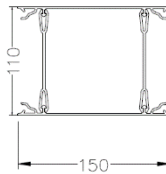
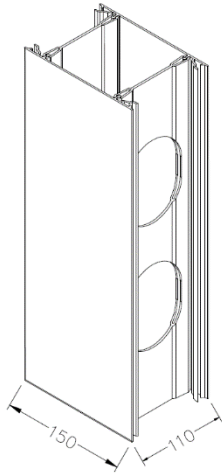

PLAN

### PS-110 Panel Spacer

The Panel Spacer is installed in a vertical direction. Used as a 150mm spacer within the main form and is clipped into the male anchors on both ends.

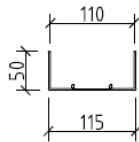
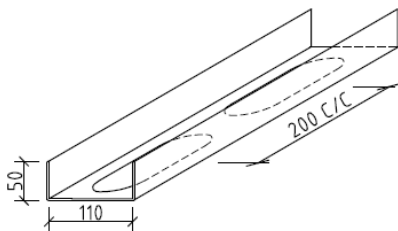

PLAN

### BT-110 Bottom Track

The Bottom Track is installed in a horizontal direction and is used as a guide for the bottom of the wall to keep the panels into alignment.

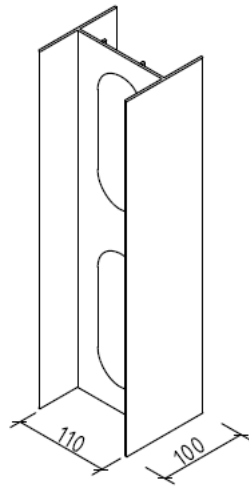

### PC-110 Panel Connector

The Panel Connector can be used both vertically and horizontally when joining the panels where no anchors are available. Use screws to fasten.

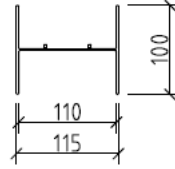

#### PLAN

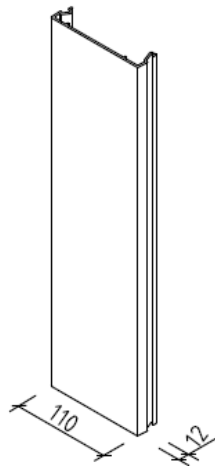

### ECM-110 End Cap Male

The Male End Cap is installed in a vertical direction. Used to cap off the end of the panel and is clipped into the female anchor.

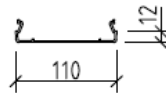

#### PLAN

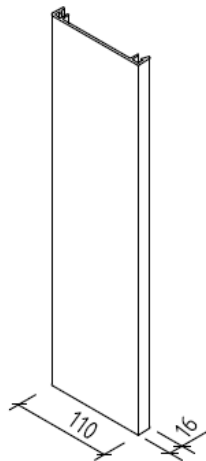

### ECF-110 End Cap Female

The Female End Cap is installed in a vertical direction. Used to cap off the end of the panel and is clipped into the male anchor.

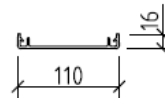

#### PLAN

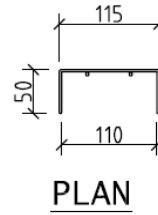
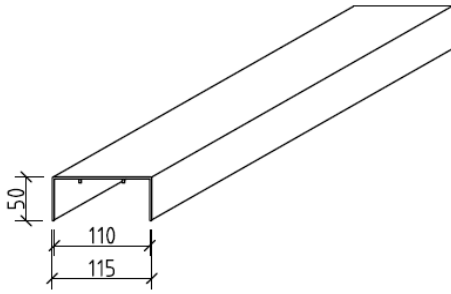

### BT-110 Bottom Track

The Bottom Track is installed in a horizontal direction and is used as a guide for the bottom of the wall to keep the panels into alignment.

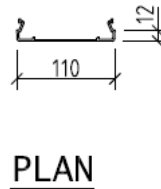
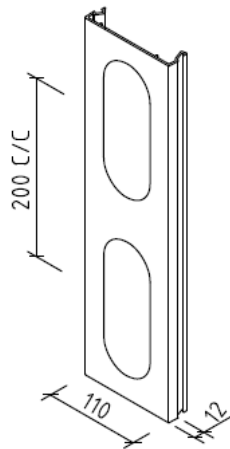

### JT-110 Junction Track

The Junction Track is installed in a vertical direction at wall intersections to create a T-Junction or corner off the main form.

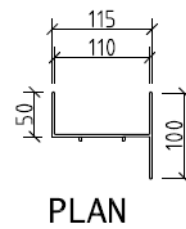
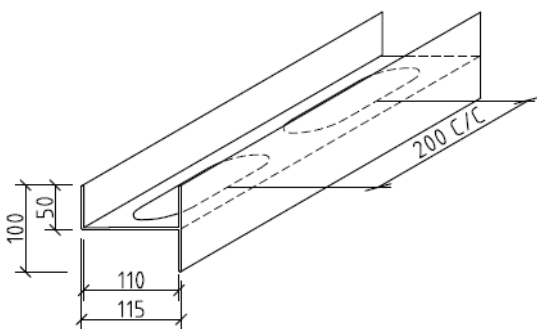

### EF-110 Edge Flashing

The Edge Flashing is used similarly as the Bottom Track on perimeter applications. Commonly used for perimeter walls, lift shafts and stairwells whereby the double flanged side is designed to cover the cold joint where the wall meets the concrete slab.